



SWITZERLAND



INCLUDING
ACOUSTIC
SOLUTIONS

SWISSCLIC PANEL

Wand- und Deckenlösungen |
Wall- and Ceiling Solutions



Holz in Bestform • Wood at its best

 **SWISS KRONO**

SWISSCLIC PANEL

DE Die innovative Lösung für Ihr ganzheitliches Raumkonzept: das präzise CLIC-System ermöglicht die einfache und schnelle Montage ohne Spezialwerkzeuge. An Wand und Decke werden die einzelnen Teile praktisch fugenlos zu einer Fläche nach individuellen Bedürfnissen zusammengefügt. So realisieren Sie Wohn(t)räume. Der Fantasie sind keine Grenzen gesetzt.

FR La solution novatrice pour créer votre concept d'ensemble de l'espace: le système CLIC précis permet un montage simple et rapide sans outils spéciaux. Les différentes pièces sont assemblées sur le mur et au plafond pratiquement sans joint pour créer une surface selon les besoins individuels. Vous réalisez ainsi les pièces d'habitation dont vous avez rêvées. Votre créativité ne connaîtra aucune limite!

IT La soluzione innovativa per la progettazione completa del vostro spazio: la precisione del sistema CLIC consente il montaggio semplice e rapido senza utensili speciali. A parete e a soffitto, i singoli pezzi si uniscono in modo pratico e senza giunti, per formare una superficie in grado di rispondere alle esigenze individuali. Nascono così ambienti da sogno. Non ci sono limiti alla fantasia.

EN The innovative solution for your concept of integrated space: the precision of the CLIC system make each installation quick and easy with no need of special tools. On walls or ceilings, the separate pieces are seamlessly joined to create the surface you want. Make the living space of your dreams comes true. There are no limits to your imagination.

ES La solución innovadora para su concepto espacial integral: el sistema CLIC preciso permite el montaje sencillo y rápido sin herramientas especiales. Las piezas se ensamblan en la pared y el techo, prácticamente sin juntas, formando una superficie según las necesidades individuales. Así realiza usted su(s) espacio(s) habitable(s). No hay límites para su fantasía.

PT A solução inovadora para o seu conceito espacial integral: o sistema CLIC preciso permite uma montagem simples e rápida sem ferramentas especiais. Na parede e no teto, as peças isoladas são montadas praticamente sem emendas, criando uma área em função das suas necessidades individuais. Assim se criam espaços de sonho, sem limites para a fantasia.



SWISSCLIC SYSTEM 4

SWISSCLIC PANEL-A 4

SWISSCLIC ELEMENT-A 5

SWISSCLIC PANEL-S 6

ACOUSTIC SOLUTION 8

DECORS 12

COLORS 12

WOOD 14

CEMENT 22

ACCESSORIES 24

TOOLS 27

INSTALLATION GUIDE 28

PACKING UNITS 30

OVERVIEW 31



SWISSCLIC SYSTEM

SWISSCLIC PANEL-A

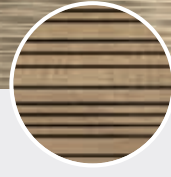

DE SWISSCLIC PANEL-A bietet sechs authentische und moderne Oberflächen, in zwei Schlitzmustern, schnell zu verlegen, pflegeleicht und robust.

FR Le SWISSCLIC PANEL-A propose six surfaces authentiques et modernes, il est d'un assemblage rapide, facile d'entretien et robuste, en deux modèles de rainures.

IT SWISSCLIC PANEL-A offre sei autentiche e moderne superfici, in due motivi intagliati, rapide da posare, e di facile manutenzione e robuste.

EN SWISSCLIC PANEL-A comes with six authentic, modern surfaces, two slot patterns, is simple to install, easy care and robust.

ES El SWISSCLIC PANEL-A ofrece seis superficies auténticas y modernas, con dos patrones de ranuras, robustas y fáciles de instalar y cuidar.

PT O SWISSCLIC PANEL-A oferece seis superficies autênticas y modernas, com dois padrões de ranhuras, robustas y fáciles de instalar y cuidar.

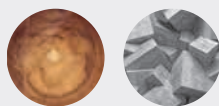
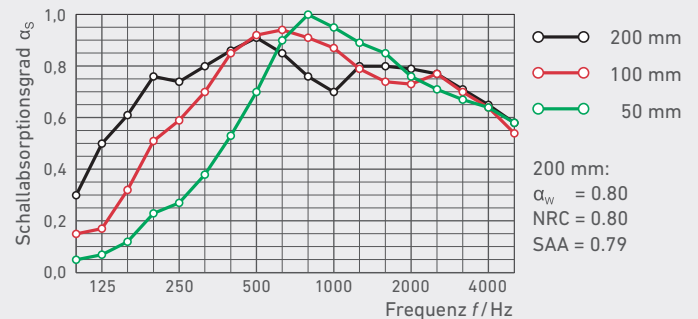
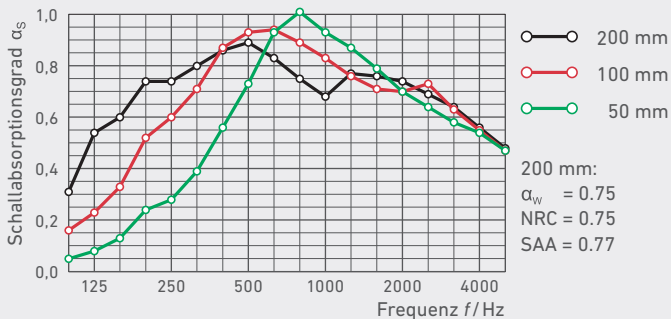

AVAILABLE IN
COLORS | **WOOD** | **CEMENT**

SWISSCLIC ELEMENT-A

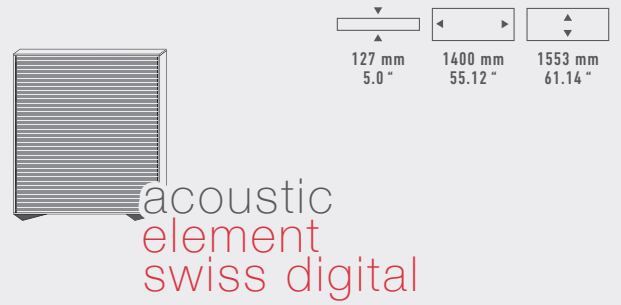
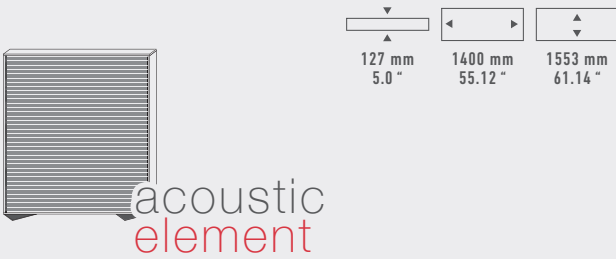

- DE** Bausatz zum selber Zusammenbauen.
- FR** Kit pour assembler soi-même.
- IT** Kit per montaggio autonomo.
- EN** Kit for self installation.
- ES** Kit para el ensamblaje en su casa.
- PT** Kit para automontagem.

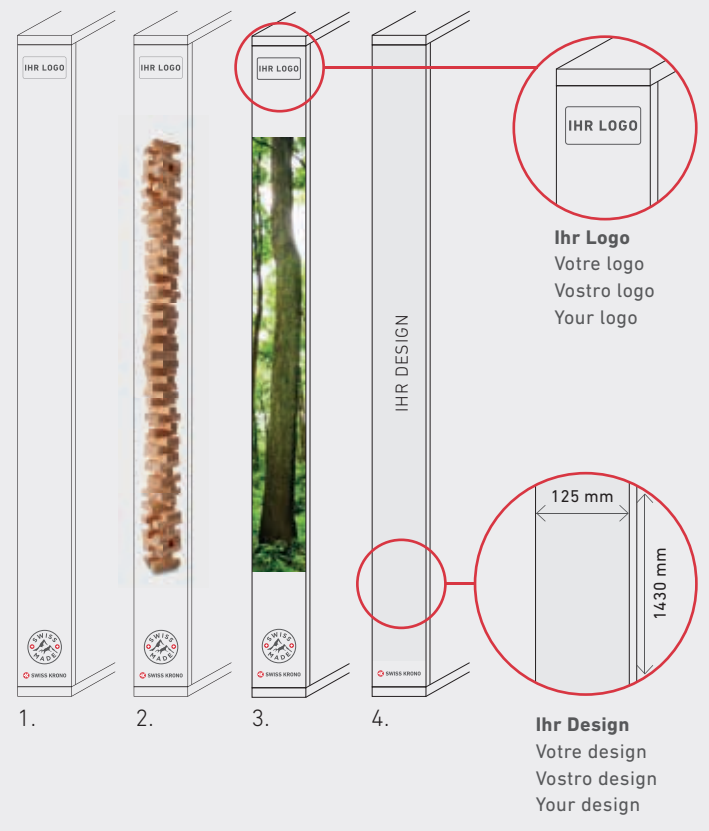
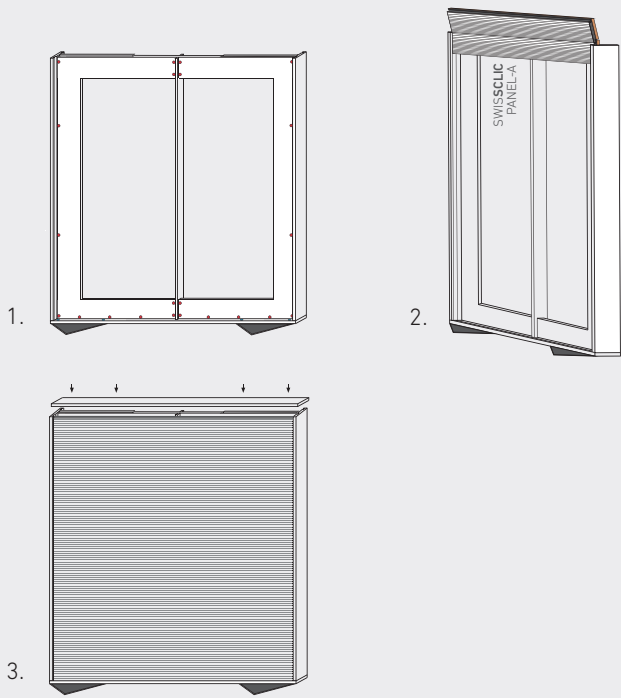

SWISSCLIC SYSTEM

SWISSCLIC PANEL-S



10 mm 0.4 "	1380 mm 54.33 "	187 mm 7.36 "

DE SWISSCLIC PANEL-S bietet zwölf authentische und moderne Oberflächen, einfach und schnell zu verlegen, pflegeleicht und robust.

FR Le SWISSCLIC PANEL-S propose douze surfaces authentiques et modernes, avec un montage simple et rapide, il est facile d'entretien et robuste.

IT SWISSCLIC PANEL-S offre dodici superfici moderne e autentiche, dal montaggio semplice e rapido, robuste e di facile manutenzione.

EN Offering twelve authentic and modern surfaces, SWISSCLIC PANEL-S can be installed quickly and easily and is easy care and robust.

ES SWISSCLIC PANEL-S ofrece doce superficies auténticas y modernas, de montaje sencillo y rápido, que requieren pocos cuidados y son resistentes.

PT SWISSCLIC PANEL-S oferece doze superfícies autênticas e modernas, simples e rápidas de instalar, robustas e de fácil manutenção.

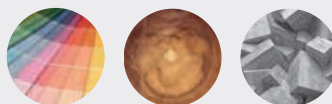

AVAILABLE IN
COLORS | WOOD | CEMENT

REFERENCES

ONLINE PRODUCT VIDEO
WWW.SWISSKRONO.CH

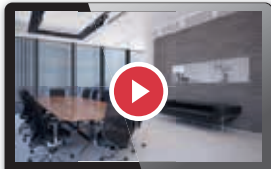

ACOUSTIC SOLUTION

FACTS

DE 60-70%...

... der Schüler verstehen die Lehrer nicht richtig!
... der Büroangestellten sind überzeugt, dass sich ihre Produktivität steigert und die Fehlerquote kleiner wird, wenn man den Lärm in ihrer Umgebung reduziert.
... der Angestellten in Grossraumbüros empfinden Lärm als den grössten Störfaktor.

FR 60-70%...

... des élèves ne comprennent pas leurs professeurs!
... des employés de bureau sont convaincus que leur productivité augmente et le taux d'erreur diminue, si l'on réduit le bruit dans leur environnement.
... des employés dans les grands bureaux trouvent que le bruit est le facteur perturbant le plus important.

IT 60-70%...

... gli studenti non capiscono bene i loro insegnanti!
... gli impiegati sono convinti che la loro produttività aumenti e il tasso d'errori diminuisca riducendo il rumore nell'ambiente in cui operano.
... gli impiegati dei grandi uffici ritengono che il rumore sia il maggiore fattore di disturbo.

EN 60-70%...

... of the students don't understand their teachers properly!
... of the office workers are convinced that they will become more productive and make fewer mistakes when the noise levels in their environment are reduced.
... of the employees in open space offices feel distracted by noise

ES 60-70%...

... los alumnos no oyen a su maestro!
... los empleados de oficina están convencidos de que con menos ruido aumentará su productividad y se reducirá la cuota de defectos.
... los empleados que trabajan en oficinas diáfanos perciben el ruido como el factor de interferencia más importante.

PT 60-70%...

... os professores não entendem bem os alunos!
... os empregados de escritório estão convencidos de que a produtividade aumenta e a taxa de erro diminui se o ruído ambiente for reduzido.
... os funcionários em escritórios em open space consideram o ruído o maior fator parasita.

DE Räume können dank dem Einsatz von SWISSCLIC PANEL-A ihren eigentlichen Nutzen zurückgewinnen.

Die akustische Verbesserung ...

... steigert die Produktivität und Konzentration.
... reduziert Stress und Störungen.
... steigert die Verkäufe in Geschäften.
... bringt Zufriedenheit und ein besseres Wohlbefinden.
... steigert die Sprachverständlichkeit.

FR Grâce à l'utilisation du SWISSCLIC PANEL-A , les pièces peuvent retrouver leur véritable utilité.

L'amélioration acoustique...

... augmente la productivité et la concentration.
... réduit le stress et les dérangements.
... augmente les ventes dans les magasins.
... apporte la satisfaction et un meilleur bien-être.
... augmente la clarté vocale.

IT Grazie all' utilizzo di SWISSCLIC PANEL-A gli ambienti possono recuperare la loro reale funzione.

Il miglioramento acustico ...

... aumenta la produttività e la concentrazione.
... riduce lo stress e i disturbi.
... aumenta le vendite nei negozi.
... porta soddisfazione e regala benessere.
... migliora la comunicazione.

EN Thanks to SWISSCLIC PANEL-A rooms regain their actual benefits.

The acoustic improvement ...

... enhances productivity and concentration.
... reduces stress and distraction .
... increases sales in shops.
... brings satisfaction and greater well being.
... improves the understanding of speech.

ES Gracias al empleo del SWISSCLIC PANEL-A los espacios pueden recuperar su auténtica utilidad.

La mejora acústica...

... aumenta la productividad y concentración.
... reduce el estrés y las interferencias
... incrementa las ventas en las tiendas.
... proporciona satisfacción y más bienestar.
... mejora la inteligibilidad de la comunicación hablada.

PT É possível tirar partido real dos espaços recorrendo ao SWISSCLIC PANEL-A.

A melhoria das condições acústicas...

... aumenta a produtividade e a concentração.
... reduz o stress e os erros.
... aumenta as vendas e os negócios.
... traz satisfação e mais bem-estar.
... aumenta a inteligibilidade ao falar.

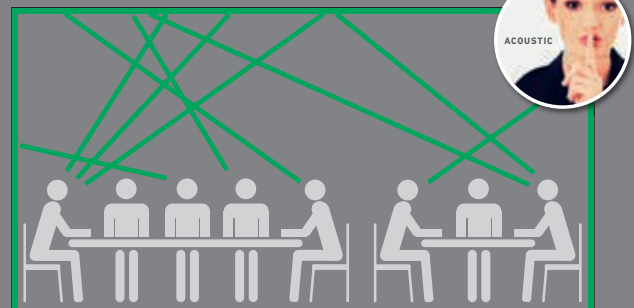
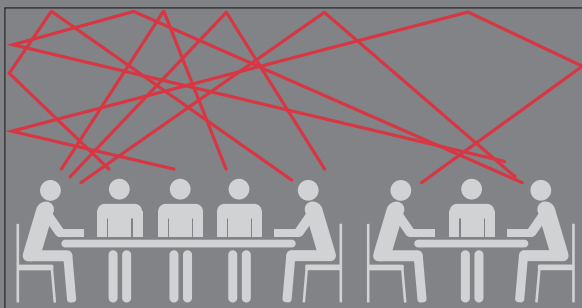

ACOUSTIC SOLUTION



PRACTICE EXAMPLE



ACOUSTIC CONFIGURATOR
WWW.SWISSKRONO.CH

DIMENSION | Dimensione | Dimensión | dimensão
10 × 7 × 3 m, 70 m², 210 m³

NUTZUNG | utilisation | utilizzazione | utilização | utilización | utilização
Kantine 35 Sitzplätze | cantine 35 sièges | mensa 35 posto a sedere | canteen 35 seats |
cantina 35 asiento | cantina 35 assento

	0 M ² SWISSCLIC PANEL-A	100 M ² SWISSCLIC PANEL-A
RAUMGEFÜHL Sensation de pièce Sensazione ambientale Room feeling Impresión por espacio Senção por espaço	unangenehm désagréable sgradevole inconvenient desagradable desagradável	angenehm agréable piacevole convenient agradable agradável
LÄRMPEGEL Niveau de bruit Livello di rumore Noise level Nivel de ruido	X 46-52 DB	39-45 DB ✓
NACHHALLZEIT Temps de réverbation Tempo di risonanza Reverberation time Tiempo de resonancia Tempo de ressonância	X 1.8-2.3 s	0.4-0.6 s ✓



ECO FRIENDLY

REFERENCES



SWISSCLIC
PANEL-A CREATIVE
D 5288 BD



SWISSCLIC PANEL-A
CREATIVE
D 5291 OW

DECORS COLORS

PAINT PRIMER FOIL P 213 SX

DE Grenzenlose Farbmöglichkeit mit der Paint P213 SX Grundierfolie! Die homogene Oberfläche lässt sich hervorragend streichen.

FR Choix de couleurs infini avec Paint P213 SX Feuille d'apprêt! La surface homogène peut parfaitement être peinte.

IT La pellicola di fondo Paint P213 SX consente di scegliere tra innumerevoli colori! La superficie omogenea si presta perfettamente alla verniciatura.

EN Unlimited colour options with the Paint P213 SX priming foil! The homogeneous surface is easy to paint.

ES ¡Posibilidades cromáticas infinitas gracias al folio de imprimación Paint P213 SX! Su superficie homogénea se presta excelentemente para el pintado.

PT Opção ilimitada de cores com a película de primário Paint P213 SX! A superfície homogénea é excelente para ser pintada.





VENICE WHITE
K 101 SX (NCS S 0502-Y)



DECORS WOOD

DE SWISSCLIC PANEL Dekore in Holz sind nicht nur das Bild einer massiven Wand- und Deckenverkleidung – mit den Strukturen fühlen sie sich auch so an.

FR Les décors en bois du SWISSCLIC PANEL ne donnent pas seulement l'aspect d'un habillage de mur et de plafond massif, mais grâce à ses structures, on en a l'impression au toucher.

IT I decori SWISSCLIC PANEL in legno non solo presentano l'immagine di un rivestimento in legno massiccio per pareti e soffitti, ma grazie alla loro consistenza risultano tali anche al tatto.

EN SWISSCLIC PANEL wood decors not only present the appearance of solid wall and ceiling panelling their structures also feel like it.

ES Los diseños SWISSCLIC PANEL en madera no sólo reproducen fielmente un revestimiento macizo, mural o de techo – gracias a las texturas producen además la sensación de serlo.

PT Os decors em madeira do SWISSCLIC PANEL não são apenas a imagem de painéis maciços para paredes e tetos, também ao toque as estruturas têm esse efeito.



LOCARNO PERL WHITE
K 101 OW

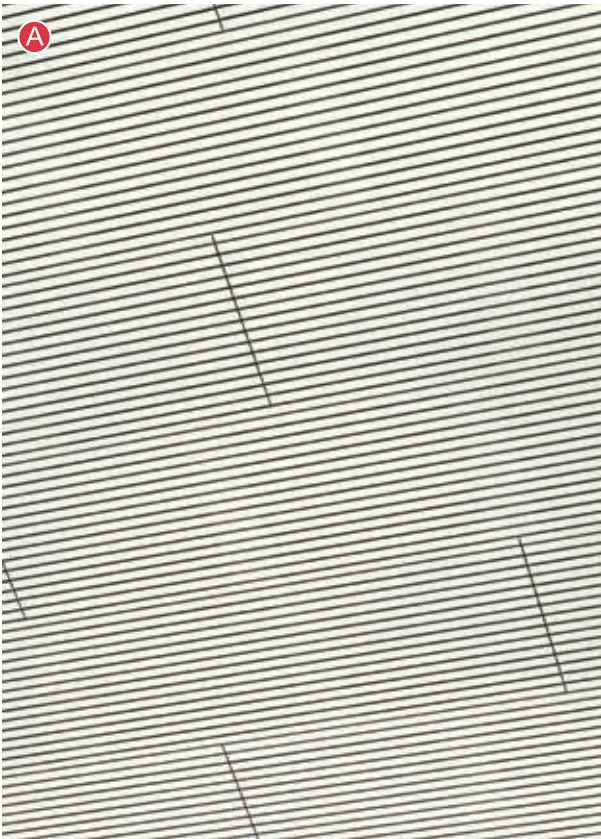

elegant

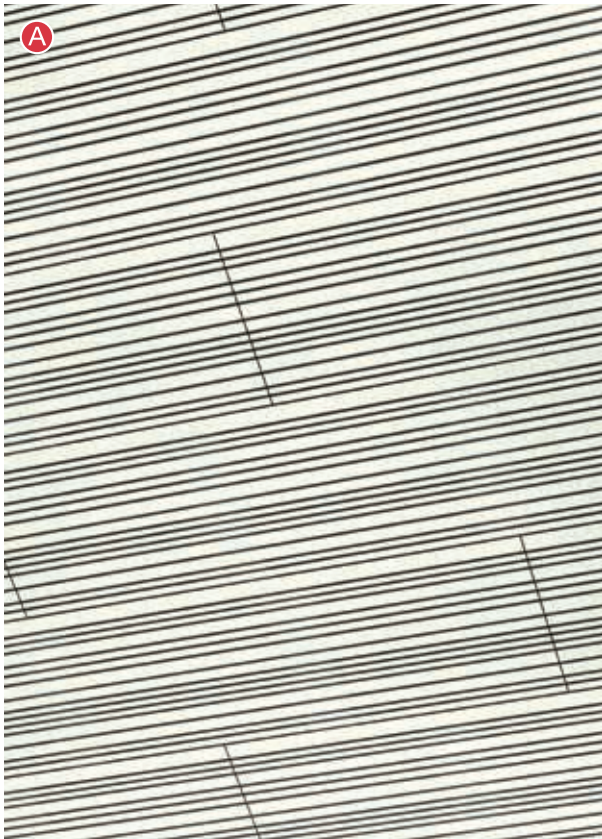

creative



ANDERMATT WHITE SPRUCE
D 5288 SD (S) BD (A)



elegant

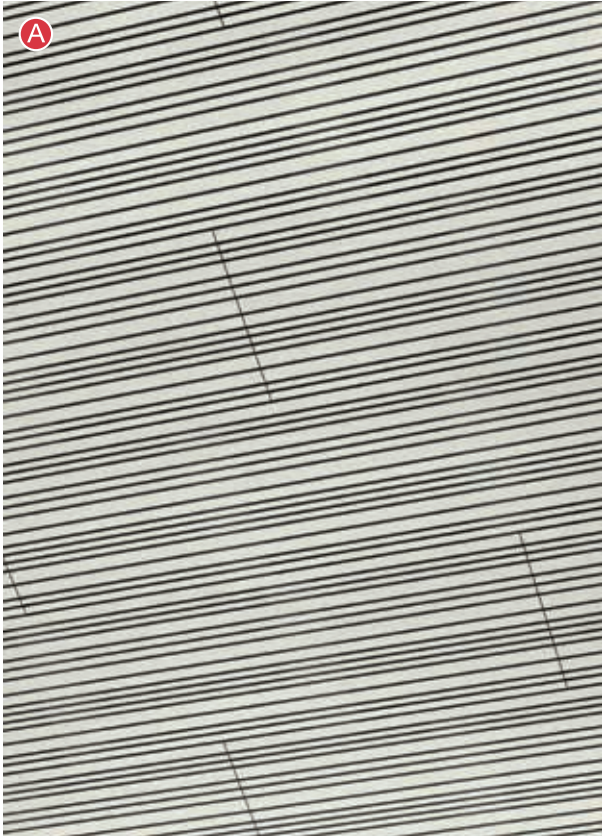

creative



LUCERNE RIVIERA OAK
D 5291 OW



elegant



creative



GOTTHARD SPRUCE
D 396 OW



elegant

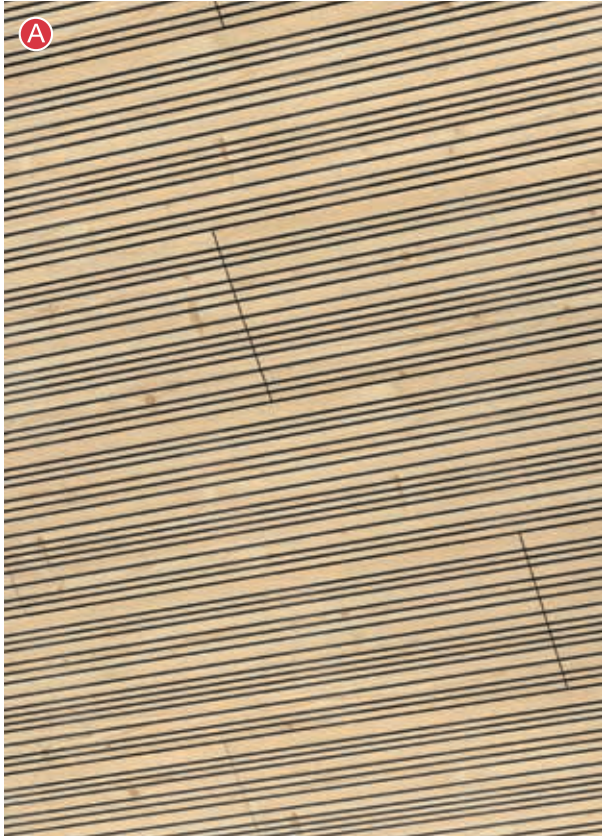

creative



MALOJA SILVER FIR
D 3045 SD (S) BD (A)



elegant



creative



MONTANA HICKORY
D 4204 CH



OREGON HICKORY GREY
D 4205 CH





GENEVA CANYON WHITE
D 2940 SD



BELLINZONA VELVET OAK
D 2693 OW



DECORS CEMENT

DE Die raue Betonoberfläche D 4109 SX wird in der modernen Architektur gerne mit warmen, weichen oder edlen Materialien in Kontrast gesetzt.

FR Dans l'architecture moderne, on aime mettre en contraste la surface de béton rugueuse D4109 SX avec des matériaux nobles chauds et doux.

IT La ruvida superficie effetto cemento D4109 SX è utilizzata nell'architettura moderna per creare un contrasto con i materiali più caldi, morbidi e nobili.

EN The rough concrete surface D4109 SX is preferred as a contrast with warm, soft, and quality materials in modern architecture.

ES En la arquitectura moderna se combina frecuentemente la superficie rugosa tipo hormigón D4109 SX con materiales cálidos, suaves y refinados, para crear un efecto de contraste.

PT A superfície de betão áspera D4109 SX é usada na arquitetura moderna em contrastes felizes com materiais quentes, suaves e nobres.



BASEL BETON WOODCON
D 4109 SX

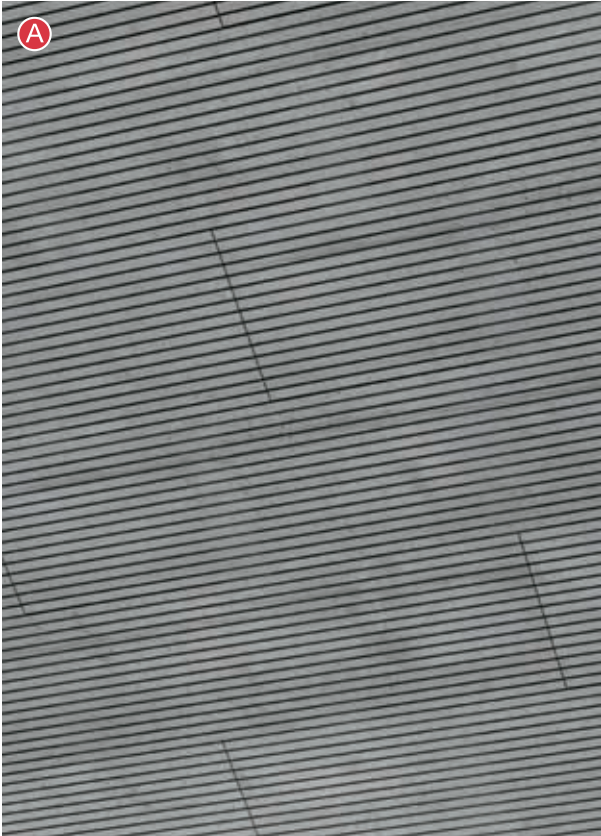

elegant

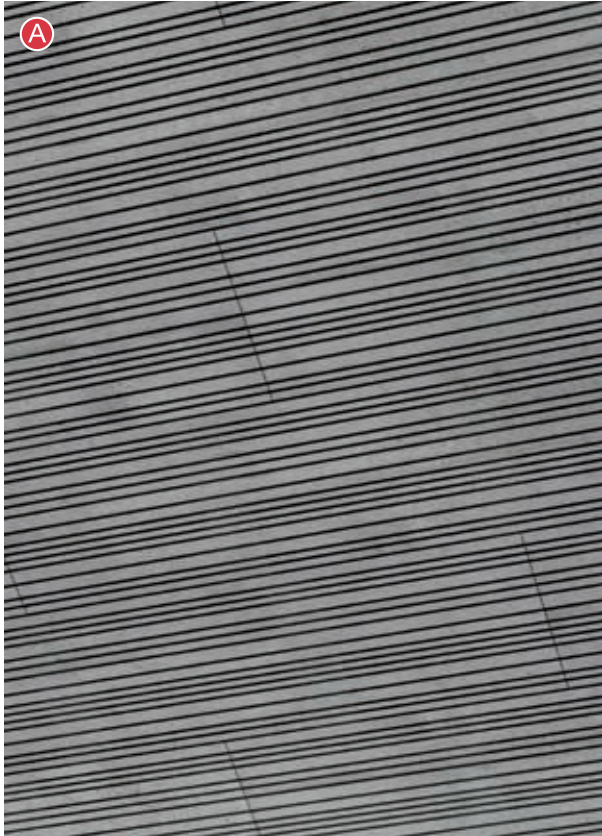

creative

ACCESSORIES

RAIL L NR. 2508



2500 mm
98.42"
ca./env./cerca
1 pce/m²

8 mm
0.3"

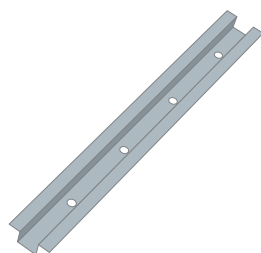

CLIP WS NR. 201

ca./env./cerca
5m²/Box

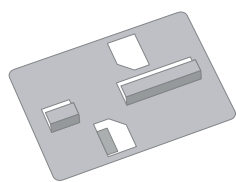

CLIP A NR. 203

ca./env./cerca
5m²/Box

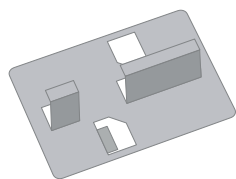

CLIP AWS NR. 202

ca./env./cerca
2.5m²/Box

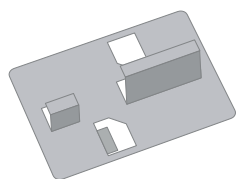

RAIL H NR. 2518



2500 mm
98.42"
ca./env./cerca
1 pce/m²

18 mm
0.7"

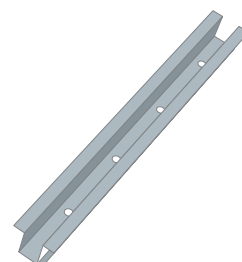

SNAP WS NR. 101

ca./env./cerca
1 Box/Room

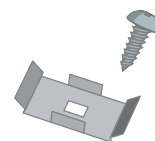

SNAP A NR. 103

ca./env./cerca
1 Box/Room

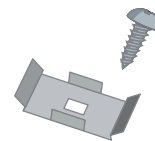

SNAP AWS NR. 102

ca./env./cerca
2 Boxes/Room

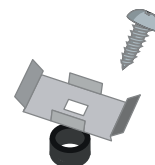

ONLINE-CALCULATOR
WWW.SWISSKRONO.CH

COMBINATION



MULTI-MONTI®-plus FIX-B BETONSCHRAUBE

vis béton | vite cemento | cement screw | tornillo concreto

Nr. 4614

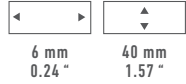

6 mm 40 mm
0.24" 1.57"

ca./env./cerca
20m²/Box

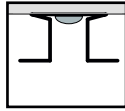
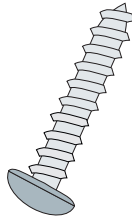

FIX-W WANDSCHRAUBE

vis murale | vite muro | wall screw | tornillo muro

Nr. 5615

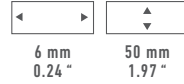

6 mm 50 mm
0.24" 1.97"

ca./env./cerca
50m²/Box

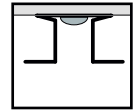

FIX-M DISTANZSCHRAUBE

vis distance | vite distanza | spacer screw | tornillo distancia

Nr. 4624

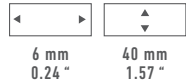

6 mm 40 mm
0.24" 1.57"

ca./env./cerca
20m²/Box

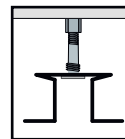
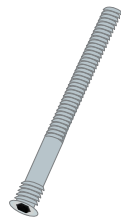

FIX-H DISTANZSCHRAUBE

vis distance | vite distanza | spacer screw | tornillo distancia

Nr. 5626

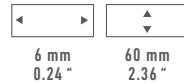

6 mm 60 mm
0.24" 2.36"

ca./env./cerca
20m²/Box

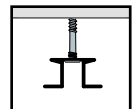
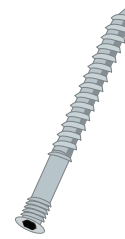

ADAPTER SYSTEM NONIUS NR. 301

für | pour | per | para RAIL H

ca./env./cerca
20m²/Box

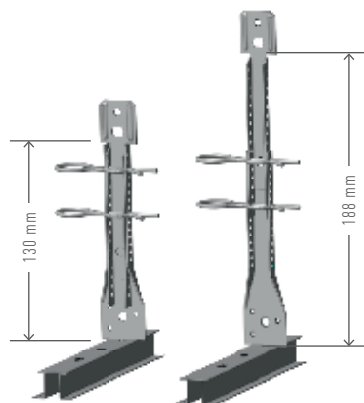

DISTANCE HOLDER NR. 330

ca./env./cerca
20m²/Box

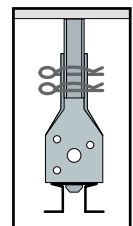
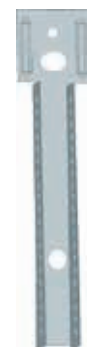

ACCESSORIES

END & DILATATION PROFILE ALUMINIUM

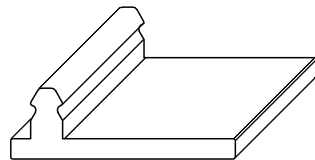

END PROFILE

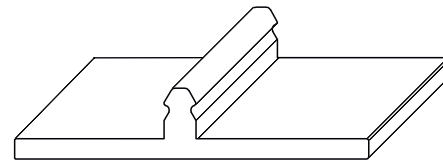
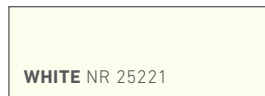

DILATATION PROFILE



BASE PROFILE ALUMINIUM

WS Nr. 2560

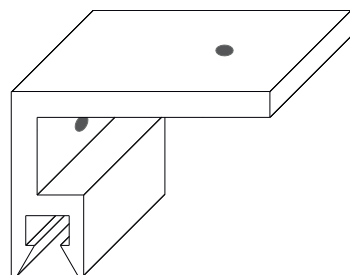

A Nr. 2570

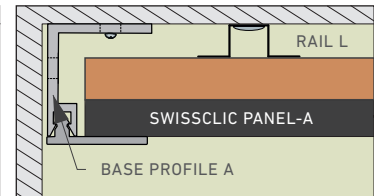
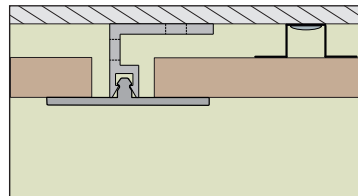
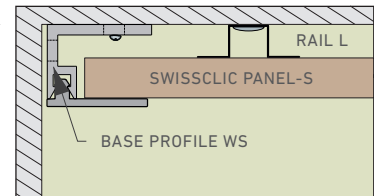
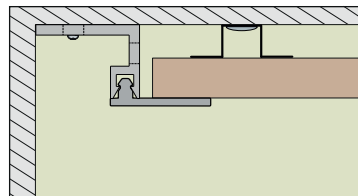

CORNER PROFILE ALUMINIUM



CORNER PROFILE WS
WHITE NR 25251

CORNER PROFILE WS
ALU ELOX NR 25250

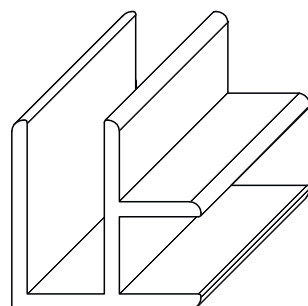

CORNER PROFILE A
WHITE NR 25301

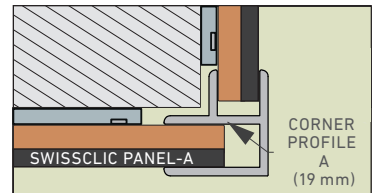
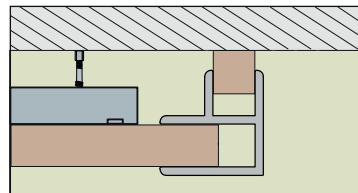
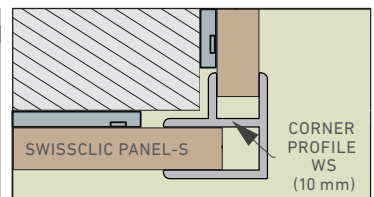
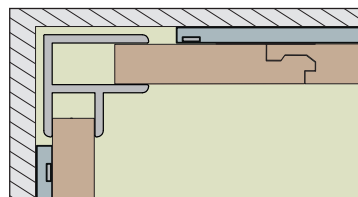

CORNER PROFILE A
ALU ELOX NR 25300



TOOLS



ONLINE-TOOLS WWW.SWISSKRONO.CH

-  PRODUCT VIDEO
-  INSTALLATION VIDEO
-  INTERIOR STUDIO
-  CALCULATOR
-  ACOUSTIC CONFIGURATOR

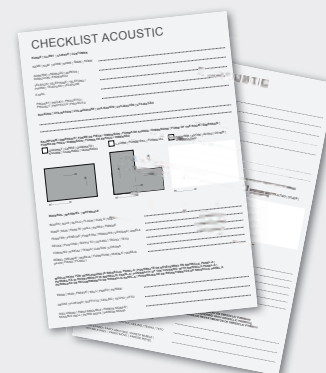

CHECKLIST ACOUSTIC
PDF-DOWNLOAD ON
WWW.SWISSKRONO.CH



SWISSCLIC
PANEL-S
D 4109 SX

SWISSCLIC
PANEL-S
D 3045 SD

SWISSNOBLESSE
STYLE
D 8021 BD

INSTALLATION GUIDE

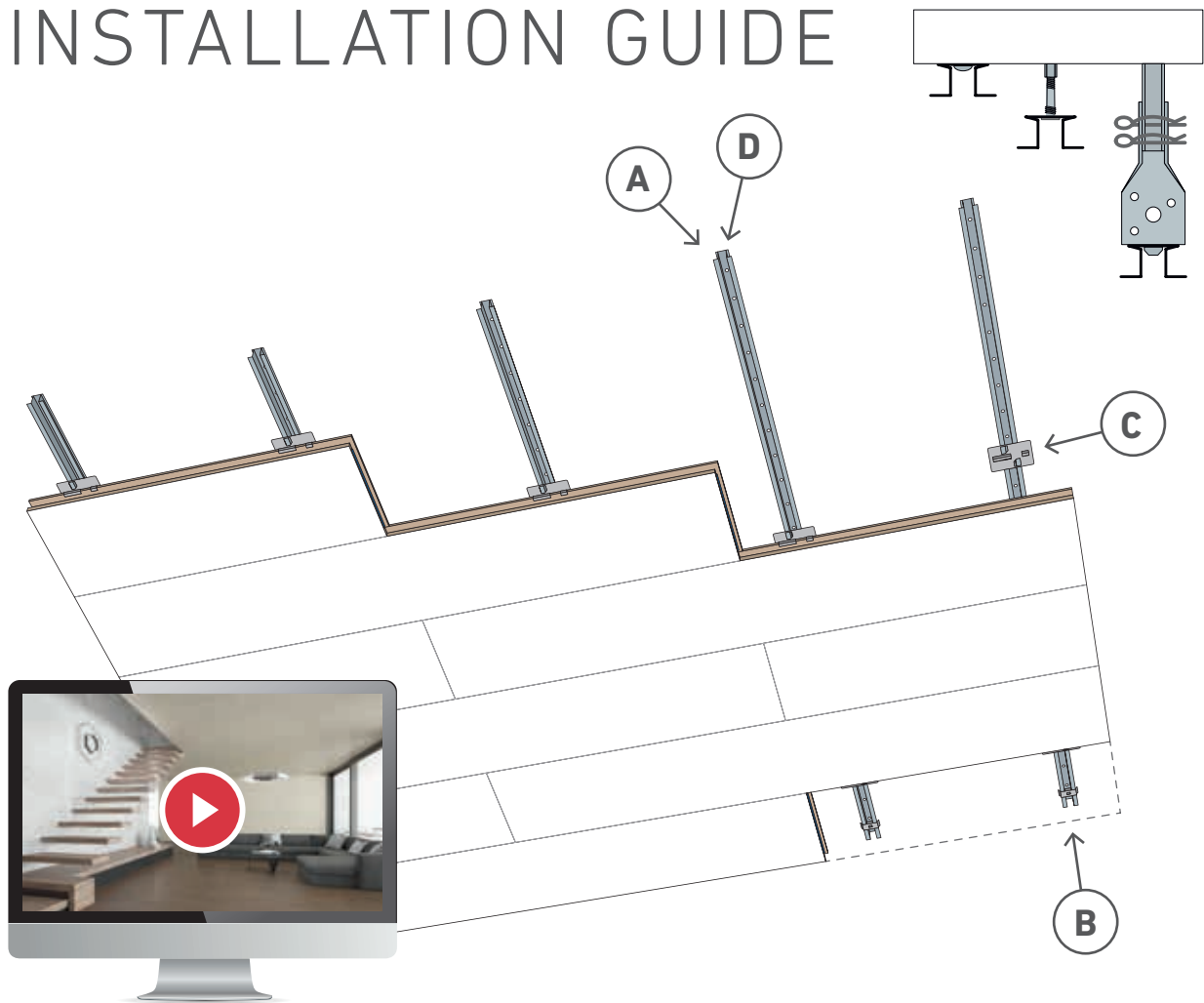

ONLINE-INSTALLATION VIDEO
WWW.SWISSKRONO.CH

SIMPLE AND RAPID

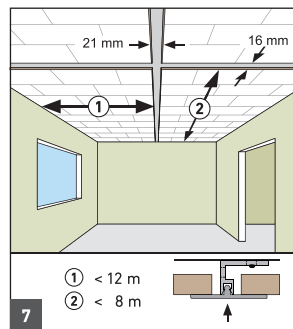
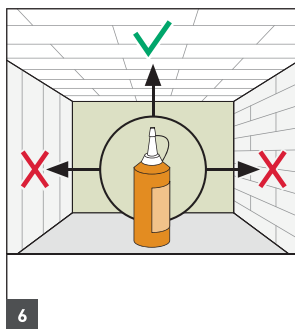
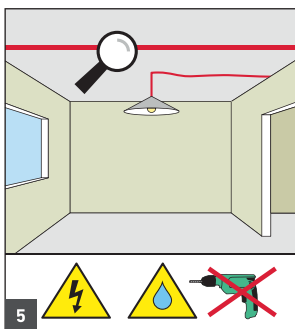
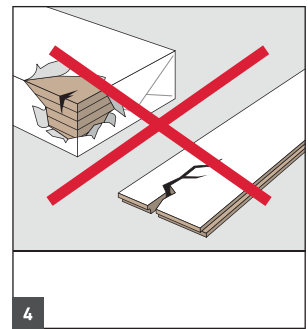
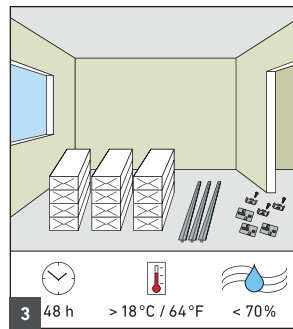
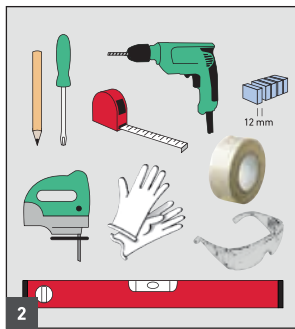
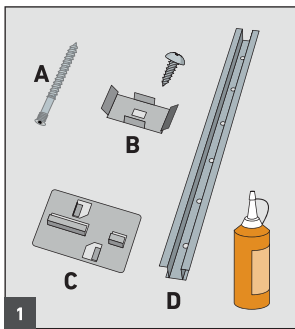

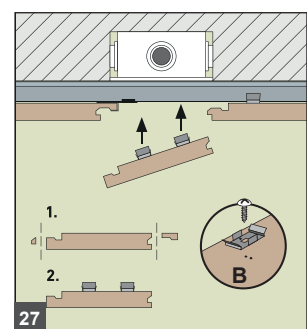
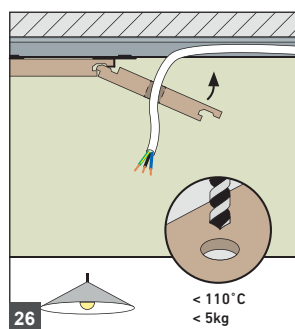
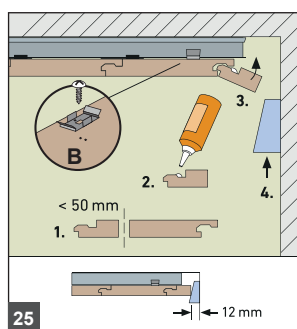
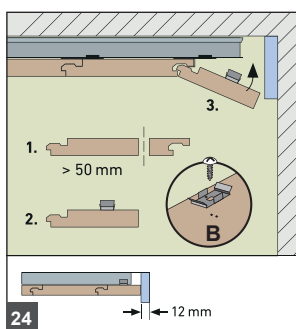
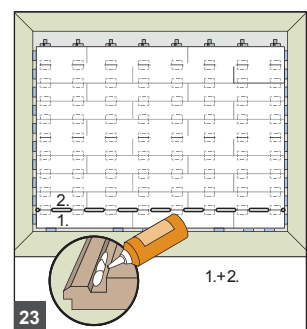
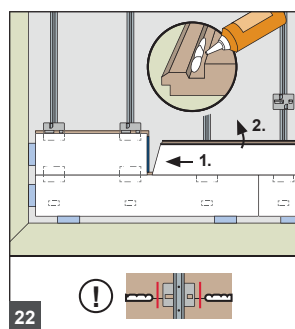
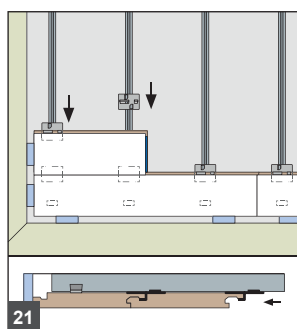
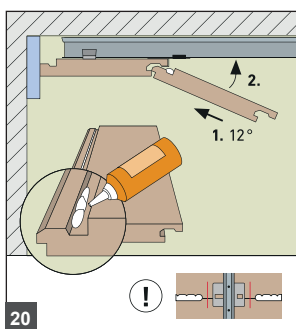
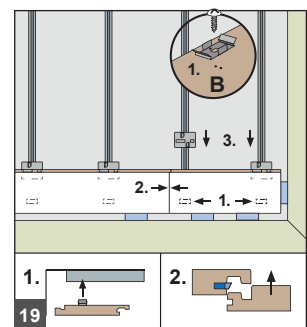
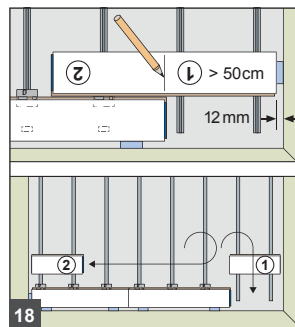
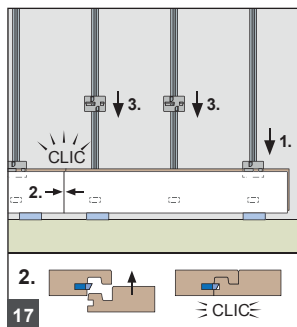
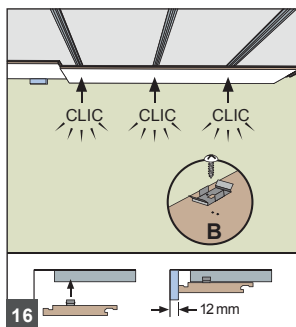
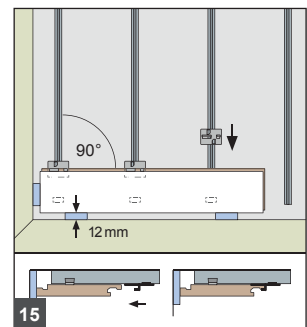
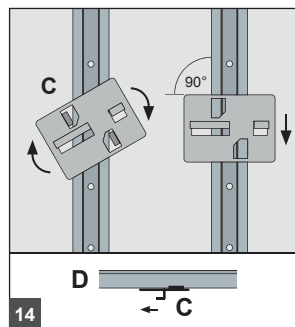
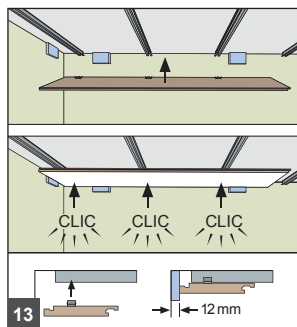
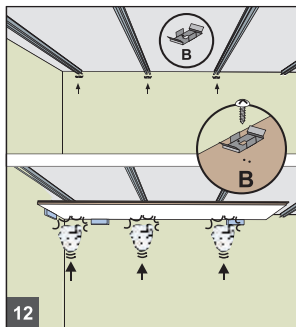
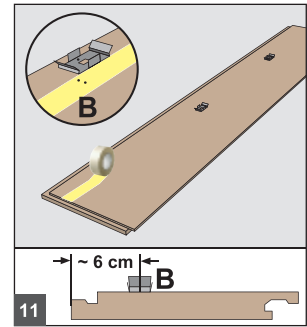
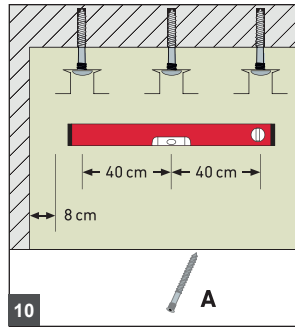
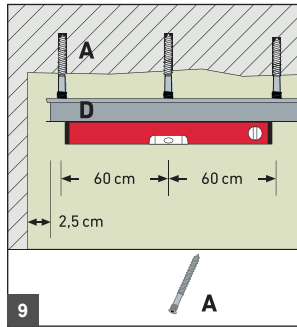
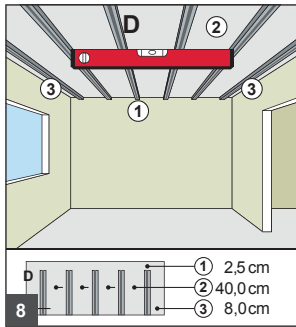

PACKING UNITS

SWISSCLIC PANEL-A

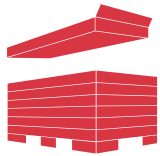

1 Box = 4 Paneelen = 1.03 m² / 8.78 kg
1 box = 4 panels = 11.08 sqft / 19.36 pounds

48 Boxen = 49.44 m² / 421.44 kg
48 boxes = 532.16 sqft / 929.12 pounds

SWISSCLIC ELEMENT-A

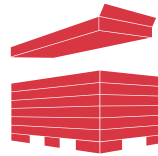

1 Box = 39 kg
1 box = 85.98 pounds

10 Boxen = 390 kg
10 boxes = 859.8 pounds

SWISSCLIC PANEL-S

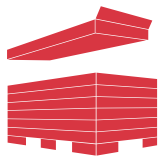

1 Box = 7 Paneelen = 1.81 m² / 16 kg
1 box = 7 panels = 19.48 sqft / 35.28 pounds

56 Boxen = 101.36 m² / 896 kg
56 boxes = 1091.03 sqft / 1974 pounds

RAIL L NR. 2508

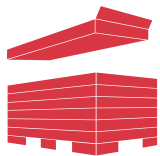

1 Box = 10 Stück = 5 kg
1 box = 10 pieces = 11.02 pounds

80 Boxen = 400 kg
80 boxes = 881.84 pounds

RAIL H NR. 2518

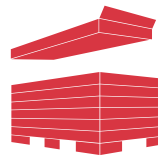

1 Box = 10 Stück = 8 kg
1 box = 10 pieces = 17.63 pounds

80 Boxen = 640 kg
80 boxes = 1410.95 pounds

CLIP



1 Box WS/A = 60 Stück | pieces
1 Box AWS = 30 Stück | pieces

SNAP



1 Box = 30 Stück | pieces

BASE & END PROFILE



1 Box = 6 Stück | pieces

CORNER PROFILE

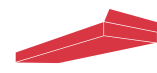

1 Box = 2 Stück | pieces

DIREKT MONTAGE | montage direct | montaggio diretto | direct installation | montaje directo | montagem directo

MULTI-MONTI®-plus FIX-B BETONSCHRAUBE

vis béton | vite cemento | cement screw | tornillo concreto



1 Box = 100 Stück | pieces

FIX-W WANDSCHRAUBE

vis murale | vite muro | wall screw | tornillo muro



1 Box = 250 Stück | pieces

DISTANZ MONTAGE | montage distance | montaggio distanza | distance installation | montaje distante | montagem distância

FIX-M DISTANZSCHRAUBE

vis distance | vite distanza | spacer screw | tornillo distancia



1 Box = 100 Stück | pieces

FIX-H DISTANZSCHRAUBE

vis distance | vite distanza | spacer screw | tornillo distancia









1 Box = 100 Stück | pieces

ADAPTER SYSTEM NONIUS

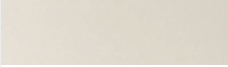

1 Box = 100 Stück | pieces

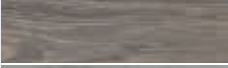
OVERVIEW

DECOR Décor Decoro		SEITE Page Pagina	PANEL-A CREATIVE	PANEL-A ELEGANT	ELEMENT-A CREATIVE	ELEMENT-A ELEGANT	PANEL-S
	P 213 SX	12					●
	K 101 SX	13					●
	K 101 OW	15	●	●	●	●	●
	D 5288 SD (BD)	16	●	●	●	●	●
	D 2940 SD	21					●
	D 396 OW	18	●	●	●	●	●
	D 2693 OW	21					●
	D 4204 CH	20					●
	D 3045 SD (BD)	19	●	●	●	●	●
	D 5291 OW	17	●	●	●	●	●
	D 4205 CH	20					●
	D 4109 SX	23	●	●	●	●	●

DE Lieferung, Garantie und Haftung gemäss Verkaufs- und Lieferbedingungen der SWISS KRONO AG. Bitte beachten Sie die lokalen Bauvorschriften.

FR Livraison, garantie et responsabilité selon condition de vente et de livraison de SWISS KRONO SA. Prière de respecter les directives de construction locales.

IT Consegna, garanzia e responsabilità ai sensi delle condizioni di vendita e fornitura di SWISS KRONO SA. Si prega di considerare il regolamento di costruzione locale.

EN Delivery, warranty and liability according to the terms and conditions of sales and delivery of SWISS KRONO AG. Please read and follow the regional building regulations.

ES Entrega e garantía de acuerdo a condiciones de venta y entrega de SWISS KRONO AG. Por favor tenga en cuenta el normativa de obras local.

PT Entrega, garantia e responsabilização pelos produtos conforme as condições de venda da Swiss Krono AG. Por favor respeite as normas de construção.



Das Zeichen für verantwortungsvolle Waldbirtschaft
Fragen Sie nach FSC-zertifizierten Produkten

INTERIOR



ONE WORLD
SWISS COLLECTION

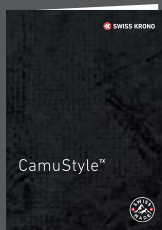

CamuStyle™



SWISSCDF



SWISSPFB



BE.YOND



SWISSWB MEHRBLATTAUFBAU
STRATIFIÉ DIRECT SWISSWB
SWISSWB-STRUTTURA MULTI-LAMA
SWISSWB-MULTI-LAYERED-STRUCTURE



SWISSDIGITAL



VERBUNDPLATTEN
PANNEAUX COMPOSITES
PANNELLI COMPOSITI
LAMINATE BONDED BOARDS

SWISS KRONO-Welt | L'univers SWISS KRONO | Mondo SWISS KRONO | SWISS KRONO-World

SWISS KRONO AG
Willisauerstrasse 37
6122 Menznau
Schweiz

T +41 41 494 94 94
F +41 41 494 94 49

info@swisskrono.ch
www.swisskrono.ch

